

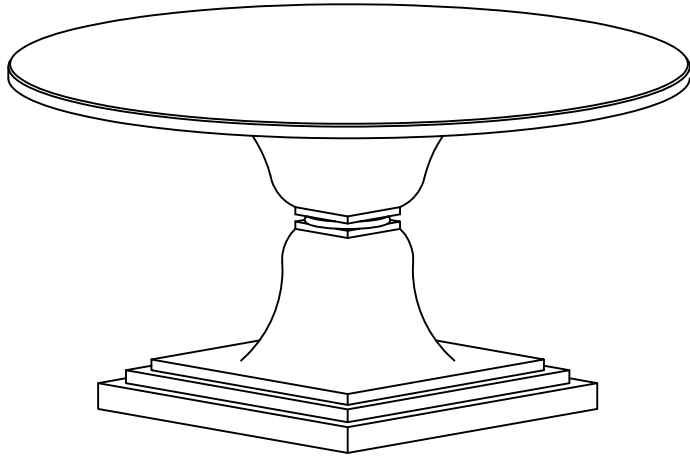



ASSEMBLY INSTRUCTION



NO.:	HARDWARE LIST	Q'TY
A		4
B		4
C		1

